

# Staying on Glidepath

## The dangers of the duck-under

BY JAMES ALBRIGHT james@code7700.com



**A Falcon 900 crosses the threshold at 10 ft., landing at Austin Executive Airport (KEDC), Texas, July 27, 2017.**

**W**henever I witness a transport category airplane cross a runway threshold by only a few feet, I think back to all the accidents in which aiming for “brick one” ended badly.

The dirty little secret about going below the glidepath is that it works. You can indeed aim for brick one, and flare the airplane so as to touch down very near the runway threshold or before the 500-ft. markers. I see it all the time. You can confirm it by looking at all the large aircraft tire prints just past the runway threshold. Of course, these pilots know there is a risk of a sudden wind gust putting the airplane down short of the threshold. But what many such practitioners don't appreciate are the other risks involved. These pilots may have failed to consider the variables of visibility, geometry and technology. There are, fortunately, easy methods to counter each factor.

When I started flying big airplanes for the U.S. Air Force, it seemed some pilots would fly a little low on glidepath,

hoping to spot the runway early. They would then aim for the first inch of runway once visual. In theory, aiming for brick one was OK because the pilot would flare the airplane so as to touch down in the first 500 ft. of runway. This was called the “duck-under” and was officially frowned upon by the service — that is, except at some squadrons where it was an accepted way to land on short runways.

In 1981, I was a second lieutenant flying the KC-135A tanker and noticed some of the pilots would adjust their aim points short of the touchdown zone on short runways. “Gee sir,” I would say in my “butter bar”-speak, “isn't it kind of risky intentionally flying below glidepath? What if we make a mistake?” The inevitable response: “I'm not planning on any mistakes. Are you?”

### Last Flight of Cobra Ball

That same year, while I was wondering about aim points in my tanker, an RC-135S spy plane crashed short of the

runway at Shemya Air Force Station (PASY), now Eareckson Air Station, on Shemya, one of Alaska's Aleutian Islands. The aircraft, Cobra Ball, was a highly modified Boeing 707 with huge camera ports on the right side designed to take high-resolution pictures of Soviet test missile shots. It was an important Cold War mission that required its crews to fly long operational and training missions and then fly a demanding precision approach radar (PAR) approach to the small island, where low ceilings and high crosswinds prevailed.

The pilot had flown most of his PAR approach “slightly below glidepath,” briefly flew “slightly above,” but ended “well below” after sighting the approach lights.

In a PAR approach, the controller views the vertical and horizontal progress of a descending aircraft's radar return, known as “skin paint,” against a 3-deg. glidepath and an extended runway centerline. The pilot attempts to hold assigned heading and a vertical velocity rate down to a 100-ft. decision altitude. The Cobra Ball's vertical velocity indicator was a purely mechanical device that lagged actual vertical velocity by as much as 9 sec., so the pilot was required to factor this lag when turning the controller's instructions into pitch and power settings. The pilot's only situational awareness came from the controller's voice. A PAR approach is demanding on a good day; it is extremely difficult with low visibilities and high crosswinds.

One need only read the last 1 min. and 43 sec. of the PAR tape to understand what happened. RFC is the radar final controller; 66 is the aircraft's call sign, Exult 66; and TWR is the tower controller.

RFC: “Going slightly above glidepath; heading one zero six.”

RFC: “Turn left heading one zero



U.S. AIR FORCE

**The Shemya runway on Attu Island, Alaska.**

very similar model of the Boeing 707, an EC-135J. We were much heavier than the classic KC-135A tanker, had larger engines with longer engine acceleration “spool up” times, and flew a much faster final approach speed. And our brakes were fair, at best. It was a natural reaction for many of our

pilots to aim short when faced with a contaminated runway. I’ve flown into Shemya a few times and the cliff that sits at the end of Runway 10 is intimidating. All of my landings to that runway were in good visibility underneath about a 400-ft. ceiling and a 25-kt. crosswind. You can get used to seeing the approach lights off to the side while crabbing the airplane just prior to landing. When ducking under, those approach lights appear higher in the windshield. I suppose you can get used to that, too. But the weather doesn’t have to be rotten to pose a duck-under risk.

**Last Flight of C-GXPR**

Prior to upgrading airplanes, the crew of Bombardier Global 5000 C-GXPR were frequent visitors to Fox Harbour Airport (CFH4), Ontario, Canada, flying their trusty Challenger 604. The airport has a 4,885-ft. runway, with an 80-ft. displaced threshold on the end in use, thus reducing the available runway to 4,805 ft. Just short of the displaced threshold was an unpaved area of grass, sloping up from a road to the runway.

The crew computed that 4,300 ft. were required for landing and planned on a touchdown at 500 ft. Mathematically it all worked out with 5 ft. to spare, except the Global 5000 was designed with a 50-ft. threshold crossing height; a touchdown at 500 ft. would require a duck-under. As is usual with these accidents, the reasons behind the crew’s duck-under decision are, well, complicated.

If you aren’t flying something in the Boeing 747-size class, you should certainly know that the near and middle sets of a visual approach slope indicator (VASI) are for you, while the middle and far sets are for the jumbos. This makes intuitive sense, since the large jet’s pilots

are sitting higher and farther ahead of their aft-most set of landing gear. If you don’t often fly into airports not designed for jets, you may be surprised to learn that not all precision approach path indicators (PAPIs) are installed the same distance along the runway. You won’t find the explanation in the Aeronautical Information Manual or any other pilot resource. But FAA Order JO 6580.2B, Visual Guidance Lighting Systems, provides an explanation as to why not all PAPIs are created equal.

If an instrument landing system (ILS) glideslope is installed, the PAPI should be sited and aimed to coincide with the electronic glideslope. If an ILS is not installed, the PAPI is sited to provide a required threshold crossing height (TCH) and clearance over obstacles in the approach area. The required TCH depends on the primary aircraft type the airport expects and is selected by the airport manager. At issue is the height of the pilot’s eyes in the cockpit above the wheel height when landing. Aircraft with 10 ft. or less cockpit-to-wheel height will be aimed to have a visual crossing height of 40 ft. Taller aircraft are aimed even higher, with Boeing 747s and similar aircraft at 75 ft.

The PAPI is typically installed 1,000 ft. beyond the runway threshold but can be installed closer on shorter runways. An abbreviated PAPI (APAPI) can be installed on runways with limited space. Whereas a PAPI provides five incremental indications (too high, slightly high, on path, slightly low, too low), an APAPI only provides three (too high, on path, too low). The APAPI at Fox Harbour was located 480 ft. from the threshold, well before the customary 1,000-ft. location. The maximum eye-to-wheel height for an APAPI system is 10 ft. The Global 5000’s eye-to-wheel height was computed to be 17.2 ft.

Flying a conventional 3-deg. glide-path given by a PAPI designed for aircraft in the Global 5000 size category would have crossed the threshold at approximately 50 ft. but also would have touched down beyond the pilot’s stated goal of 500 ft. Flying the APAPI would have made the touchdown goal attainable but would have eroded the TCH safety margin to less than 30 ft. But the pilots flew even lower, probably aiming for brick one. A classic duck-under. But they had gotten away with it many times before in the Challenger.

The captain had made this approach and landing successfully 75 times flying a Challenger 604. The accident flight

four; 2 mi. from touchdown; slightly above glidepath.”

RFC: “Heading one zero four, turn right heading one zero six.”

RFC: “On course, heading one zero six; drifting left of course, turn right heading one zero eight.”

RFC: “Turn right heading one one zero.”

RFC: “On glidepath . . . left of course heading one one zero.”

RFC: “Going slightly below glidepath; 1 mi. from touchdown.”

RFC: “At decision height.”

66: “Sir, we’ve got the lights.”

RFC: “Roger.”

RFC: “Slightly below glidepath, slightly left of course.”

RFC: “Well below glidepath.”

RFC: “On course; over landing threshold.”

RFC: “Tower.”

TWR: “He crashed close to the end of runway one five, I mean one zero.”

The pilot exhibited very precise heading control but tended to favor the low side of the glidepath. Once he spotted the approach lights, he went well below the glidepath. That shows what happened but not why. The aircraft crashed into the approach lights that were built onto a cliff just prior to the runway, which did not have an overrun. The aircraft was torn apart. Six of the 24 crewmembers were killed. But why?

If Shemya had a standard 1,000-ft. overrun, the duck-under would have resulted in a hard landing and some good-natured ribbing from the crew to the pilot, and nothing more. But that runway didn’t have an overrun. The Air Force blamed the crash on the pilot’s misunderstanding of the impact of a headwind on his target vertical descent rate and the fact he “channelized on the approach lights.”

But blaming the pilot’s understanding of headwinds and target fixation on approach lights misses the point entirely. A year after that crash, I ended up flying a



TRANSPORTATION SAFETY BOARD OF CANADA

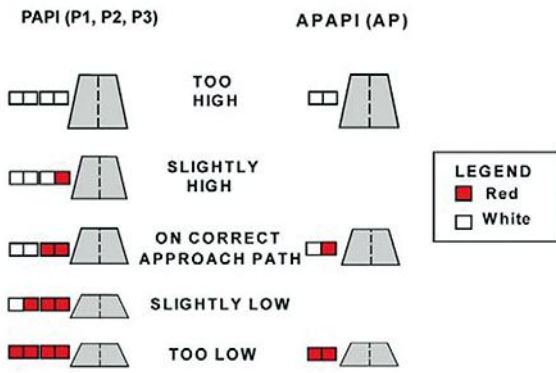

### PAPI versus APAPI indications.

was his third attempt in the larger Global 5000. Besides being heavier (87,800 lb. versus 48,200 lb. maximum allowable takeoff weight) and longer (96 ft., 9 in. versus 68 ft., 5 in.), the Global 5000 has different landing geometry. The Challenger's eye-to-wheel height is about 12 ft., or approximately 5 ft. lower than the Global's.

But there is another factor, and that is the approach geometry of each aircraft. The Challenger flies relatively nose-low on approach, which means the landing gear are not so far underneath the pilot's eyes. The Global 5000, conversely, flies relatively nose-high and the landing gear are significantly lower than the pilot's eyes. Had this Global 5000 crew flown the same approach profile in the Challenger, they would have made the runway. But, on the accident landing, the right main landing gear impacted the turf 7 ft., 6 in. short of the runway and collapsed. The Global continued down the runway with the right wing dragging. The aircraft departed the runway 640 ft. later and pivoted 120 deg. before coming to a stop. The only injury was to the first officer, but the aircraft was damaged beyond repair.

First, the mitigating factors. The crash of C-GXPR was an eye-opener for many. Few pilots have heard the term "eye-to-wheel height" and fewer still have given it any consideration. Most pilots would probably assume one

set of PAPIs are much like any other. The approach geometry of the Challenger 604 is obviously different than that of the Global. But how many pilots with experience in both aircraft understand just how much lower the landing gear is on the Global?

Now, let the Monday morning quarterbacking begin. Many of us flying aircraft in the Challenger to Global weight classes consider 5,000 ft. to be a minimum runway length. When you approach such a runway there is a temptation to cheat and aim short of the normal 1,000-ft. aim point in an at-

obstacle, and perhaps without an overrun, you will be tempted to aim for brick one. Every time a brick one landing is successful, it becomes another entry in the ledger: Brick one landings work. You have normalized a deviance from standard operating procedures.

It would be easy to say the only pilots at risk for the duck-under are those who have become habitually noncompliant or don't place enough emphasis on doing things the right way, every time. But even the most diligent pilots are at risk.

## Last Flight of Air Canada 624

While sifting through an accident report, I am often struck by the crew's complacency, habitual noncompliance or lack of a critical piece of knowledge. Not so in the case of Air Canada Flight 624, an Airbus A320 that crashed during landing on

### VPTH versus APAPI differences superimposed on side view of Fox Harbour Airport and Global 5000 landing geometry.

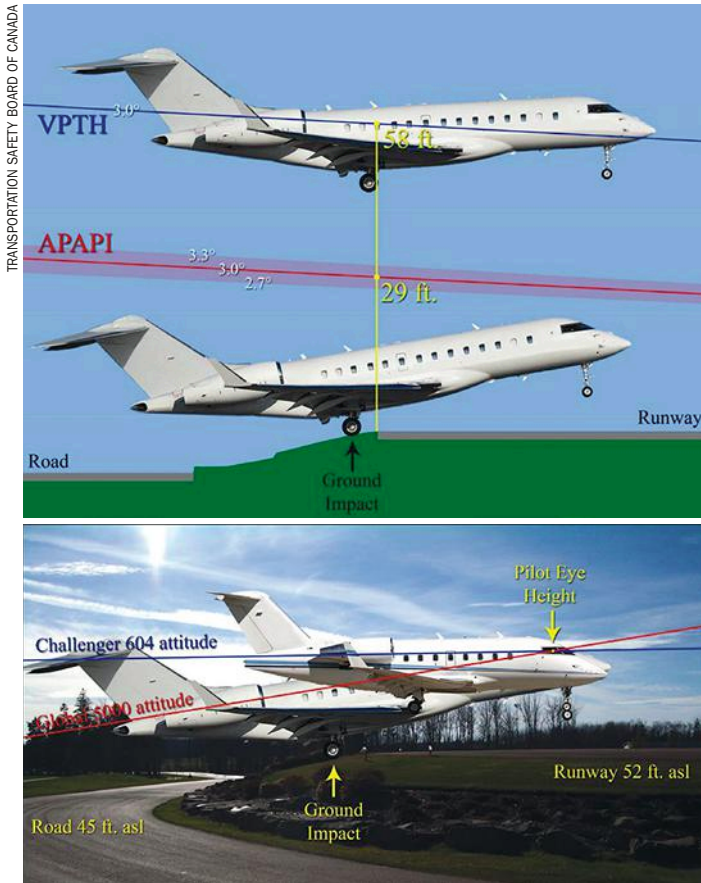

March 29, 2015. The crew appeared to be doing everything by the book during their approach into Halifax-Stanfield International Airport (CYHZ), Nova Scotia, Canada. In fact, it appears to me, the pilots only made two mistakes. The first one seems

### Global 5000 versus Challenger 604 attitude and threshold.

trivial before further research. The second one could have bitten any of us.

It was a cold night in Halifax and the winds dictated the localizer-only approach to Runway

tempt to put the wheels down short of the normal touchdown point of around 750 ft. Every time you do this, you reinforce the idea into your subconscious that aiming short is OK. The next time you face the same situation but with a runway that is just a little bit shorter, a little bit contaminated, perhaps with an

5. The crew determined a 200-ft. cold temperature correction to their final approach fix (FAF) altitude, raising it to 2,200 ft. They also adjusted their minimum descent altitude (MDA) to 813 ft. using a 23-ft. correction as well as their airline's added 50 ft. They also adjusted the descent angle from 3.08 deg. to 3.5

deg., to compensate for the higher adjustment altitude at the FAF as compared to the MDA. This adjustment surprised me. It was in accordance with a table in their airline Flight Operations Manual (FOM) and was mathematically correct. I don't have such a table in my FOM.

Another peeve of mine when reading accident reports is the cavalier nature of crews during critical phases of flight and quite often the need to redact cockpit voice recorder transcripts due to a proliferation of profanity. Not so with this crew. All briefings were thorough. Every call-out was made when needed. These guys were good.

The visibility was poor, oscillating between 0.25 and 0.5 mi. in snow. Air Canada's Operations Specifications allowed crews to conduct instrument approaches at 50% of published visibility values provided the approach was coupled. The airline's FOM further specified that in this situation the autopilot's lateral guidance had to come

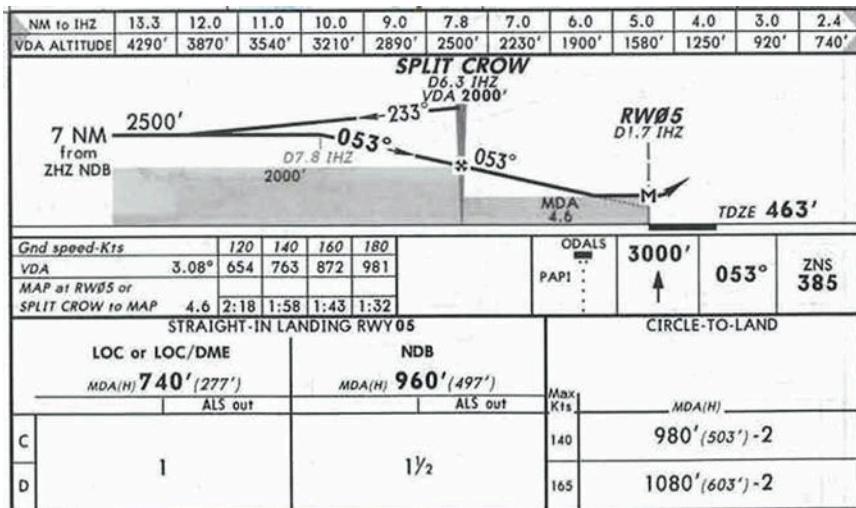

math that comes to  $0.2 \times 6,076 = 1,215$  ft. So, if everything else remained as planned, their vertical path would place them at runway elevation two-tenths of a mile before the runway. Of course, things rarely remain as planned.

**Profile view of the approach into Halifax.**

the ground up. It doesn't end at the runway's touchdown zone, it just ends at the selected angle from wherever the airplane happens to be. The crew ended up at the MDA 0.3 nm early, which comes to  $0.3 \times 6,076 = 1,823$  ft. before the runway.

The crew spotted the approach lights and continued their descent further, still coupled to the autopilot. The autopilot, for its part, was content to aim 1,823 ft. short of the touchdown zone, well short of the runway. Doing the math, they should have been 5,182 ft. from the runway at the MDA, but they were actually around 7,000 ft. from the runway. Their view of the approach lights was



TRANSPORTATION SAFETY BOARD OF CANADA

**Air Canada Flight 624 aftermath.**

from the localizer and the vertical guidance from the flight path angle (FPA) computed to cross the runway threshold at 50 ft. If you are unfamiliar with an FPA, think of an autopilot's vertical velocity or vertical speed mode converted from feet per minute to degrees. It is in many ways superior as it doesn't require adjustment with airspeed. But it does have its limitations, as this crew discovered. And that leads us to their first mistake.

Their FOM specified that 0.3 nm prior to the FAF the crew should select the FPA mode of the autopilot and set it to 0.0 deg. to maintain level flight. At the FAF the pilot is to command the required descent angle. The pilot dialed the FPA to -3.5 deg. at 0.3 nm and the aircraft began its descent 0.2 nm early. That may seem trivial, but doing the

**FPA versus flight path.**

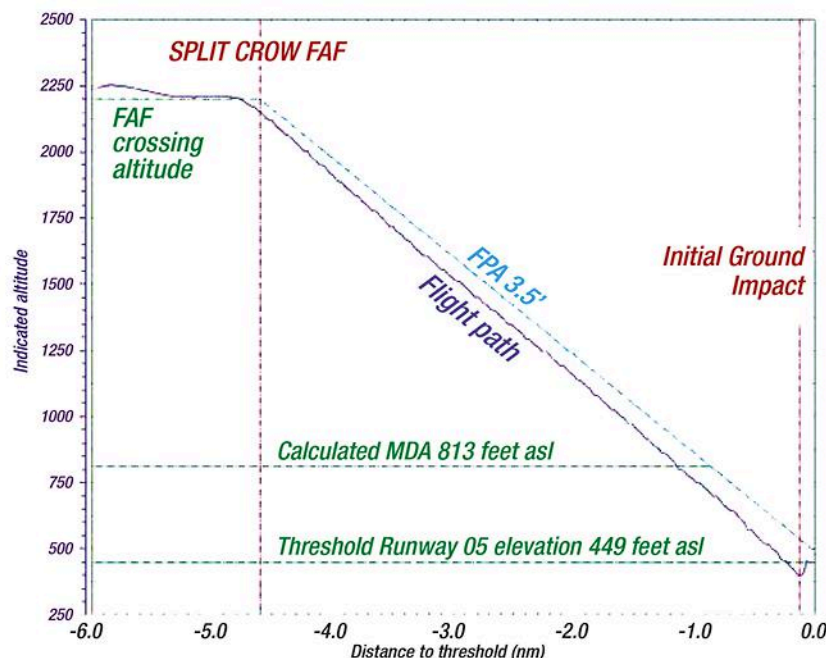

TRANSPORTATION SAFETY BOARD OF CANADA



at -2.2 deg., not -3.08 deg. Can you spot a difference of less than a degree? I certainly cannot.

They continued the coupled approach until their system's automatic call of "100," at which point the autopilot was disconnected. At the "50" call both pilots realized they were aiming for the approach lights and not the runway. The pilot initiated a go-around, but it was too late. One of the left main tires contacted an approach light located 861 ft. from the threshold. The left main gear, aft lower fuselage and left engine struck the ground. The aircraft slid onto the runway before coming to rest just 1,900 ft. beyond the threshold. There were no injuries, but the aircraft was damaged beyond repair.

Many of these accident case studies are disturbing because they leave you wondering, "How could a professional crew have done this?" But this accident is disturbing for me because it leaves me wondering, "Could I have done any better?" The 0.3-nm start descent error seems almost trivial. If I had arrived at an MDA 1,823 ft. before I should have and spotted the approach lights, I would

## Curing the Problem With Geometry

When we start our flight training, we often hear that the spot on the windshield that isn't moving is where we are headed and when flying a very small primary trainer that is mostly true. That is where your eyes are headed, but your wheels are behind and below you; they are headed short of that point. In a Cessna 152 or Piper Arrow, the difference is too small to worry about. As the aircraft gets larger, those distances become more important.

One of the lessons learned from the Global 5000 crash at Fox Harbour was the need to realize there is a difference between the height of your eyes and your wheels in a landing attitude. In my Gulfstream G450, for example, my eyes are 10.5 ft. off the ground when the airplane is in a three-point attitude. But on landing, when the main gear touch, the nosewheel is still in the air and my eyes are 13.8 ft. above the surface. While my eyes cross the threshold at 50 ft., my wheels are at 36. My margin of error is reduced.

makes you a sitting duck for those approach lights.

It is absolutely critical that pilots of transport category aircraft understand just how quickly any margin for error can be erased when failing to adhere to a 50-ft. threshold crossing height and a landing in the touchdown zone. With that understanding, pilots should realize what each type of cockpit glide-path indication is based on and what the displayed information actually means. There are four main players:

- ▶ An ILS glideslope.
- ▶ A localizer performance with vertical guidance (LPV) vertical path ((VPATH).
- ▶ A vertical navigation (VNAV) VPATH.
- ▶ An FPA.

An ILS glideslope signal is broadcast from antennas abeam your touchdown point; that's where they come from. If you follow the glideslope to landing there are two critical things to know. First, if you follow the beam, you will end up on the runway, no matter the winds or temperature. Second, the beam gets narrower the closer to the antenna you get. So, just when you want the signal to become more accurate, it does. A 3-deg. glidepath descends 318 ft. every nautical mile. The math: 6,076 ft. per nautical mile times  $\sin(3 \text{ deg.}) = 318 \text{ ft.}$  At 1 nm, flying two dots low puts you at 6,076 times  $\sin(1 \text{ deg.}) = 106 \text{ ft.}$  But crossing the threshold, 750 ft. from touchdown, the beam narrows and you will be at 750 times  $\sin(3 \text{ deg.}) = 39 \text{ ft.}$  Flying two dots low puts you at 750 times  $\sin(1 \text{ deg.}) = 13 \text{ ft.}$  over the runway.

For most LPV approaches, the tolerances are identical to the ILS. While there isn't an antenna broadcasting to your aircraft, your avionics construct the path so it appears just so. The bottom line for both the ILS and the LPV is that keeping that glideslope or VPATH needle centered ensures you end up over the threshold at an adequate height for a landing in the touchdown zone. Even flying two dots low keeps you out of the dirt, provided there are no obstacles in the way.

A VNAV vertical path is completely different. The tolerance remains constant no matter the aircraft's altitude or distance to the runway. Flying two dots low on a typical system can leave you 150 ft. too low at 1 nm, which means you will be at  $(318 - 150) = 168 \text{ ft.}$  But the tolerance is the same crossing the threshold. Flying the VNAV centered gets you to the runway. Riding the bottom of the VNAV at two dots low means you will be at runway elevation  $(150 - 50) / \tan(3$

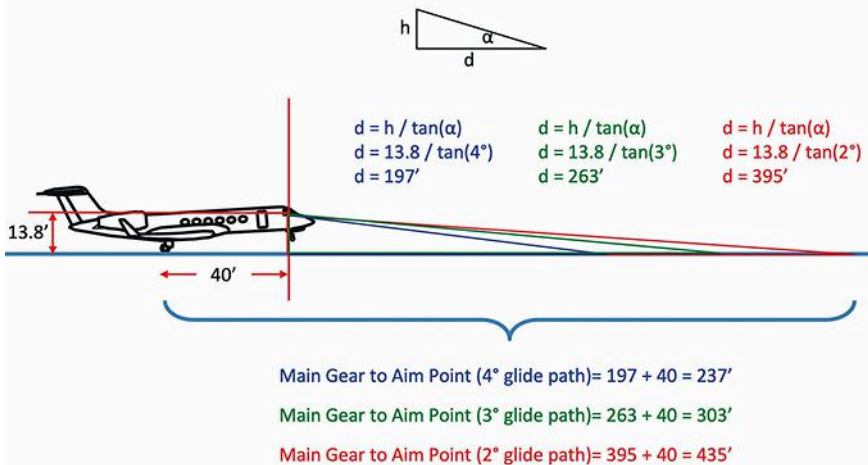

### The effect of glidepath on touchdown point versus aim point.

have left the autopilot engaged a little further, just as this crew had done. But a second reading of the report tells me I could have done better, I hope, because of a few techniques I've learned over the years. So, the only question left for me is if I would have had the presence of mind to use those techniques. But they are techniques worth knowing.

Not only are my eyes above the wheels, they are 40 ft. in front of them. But the look-down angle from the cockpit to my aim point further changes the math. Off a 3-deg. glidepath, my eyes will be 303 ft. forward of the point my main gear touch. This distance varies with airplane geometry as well as the glidepath flown. For most business jets, aiming for 1,000 ft. puts your wheels down right around the touchdown zone, provided your flare isn't exaggerated. Aiming for 500 ft. gets you just beyond the threshold. Aiming for brick one

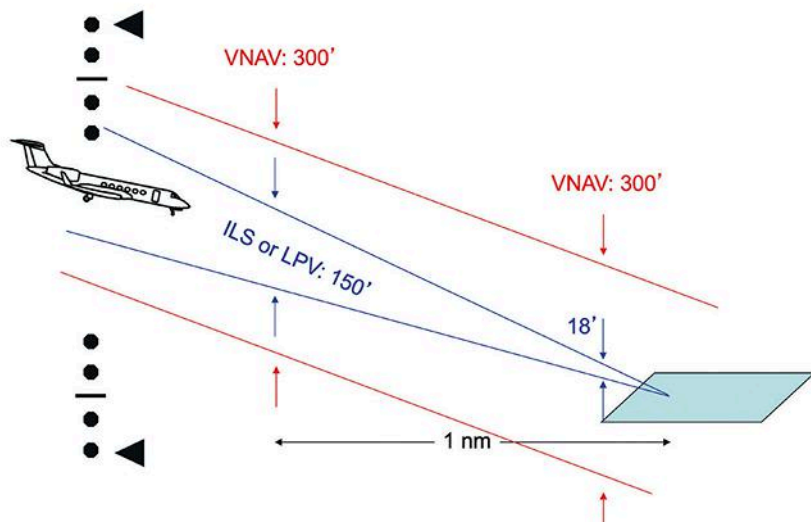

Typical full-scale deflection tolerances for ILS, LPV and VNAV glidepaths.

deg.) = 1,908 ft. short of the runway.

Unlike the ILS glideslope, the LPV VPATH or the VNAV path, an FPA is drawn from the airplane to the ground.

figure on being no lower than 300 ft. above the ground for every 1 nm from the runway. While the real number for a 3-deg. glidepath is 318 ft./nm, 300 ft./

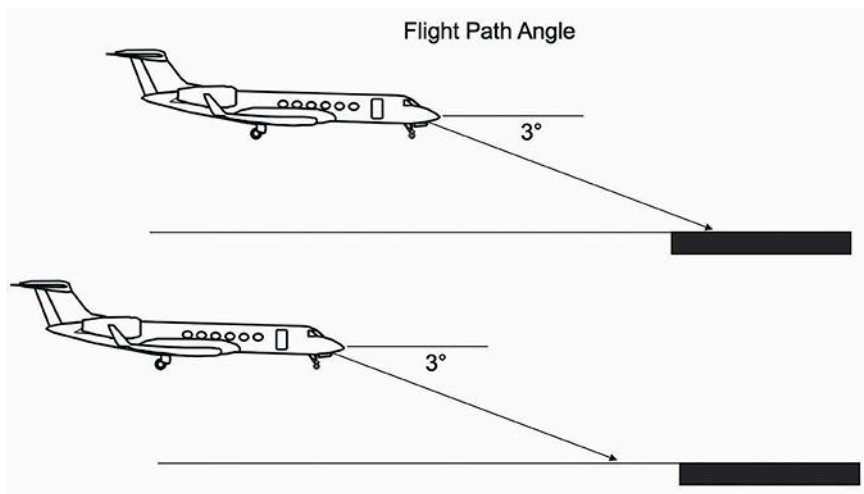

You can be precisely on the FPA while aiming several miles short.

There are obviously problems with flying a VNAV or FPA thinking you are guaranteed to end up in the touchdown zone of the runway. Either system can leave you well short of the runway. There are two methods for fixing all this: Cross-check your distance versus altitude or, if you have the technology, use the FPA and flight path vector (FPV) superimposed on the runway.

The easiest way to ensure you do not dip below a proper glidepath, even if you don't have an ILS or LPV guiding you to do that precisely, is to simply

**The flight path angle (FPA) function doesn't care where the runway is.**

nm is easy to figure and pretty close. Having a GPS readout of distance to the runway is ideal. But let's say, for example, the DME is based on a VOR 1 nm past the approach end of the runway. Simply subtract a mile to each target. Back in the days when I didn't have a better option, I would pencil these target altitudes on the approach chart.

The crew of Air Canada Flight 624 had just such a table drawn on their approach chart for them. This is an invaluable technique, but if you have

the technology, there is something even better.

## Curing the Problem With Technology

Many aircraft that display an FPA will also display an FPV. The FPA displays a line depicting where the airplane will end up if flown along a set angle above or below the airplane. As the crew of Air Canada Flight 624 discovered, the FPA doesn't care where it is in relation to the runway. The FPV displays where the airplane is headed. Both FPA and FPV show actual aircraft performance, which is of little use to the landing pilot unless presented with a third element: the location of the runway.

Aircraft with head-up displays (HUDs) or synthetic vision systems (SVSS) that will show the runway as well as an FPA and FPV have a distinct advantage in the need to arrive over the runway threshold at the correct altitude and on the runway in the touchdown zone.

This technique doesn't need an ILS, LPV, or even a VNAV. It can be flown to a runway with no approach at all. Some call it "walking the FPA," which I suppose is as good a name as any. Let's put ourselves into Air Canada Flight 624's situation at the MDA for an example.

The aircraft's autopilot was precisely flying the selected FPA, but the crew didn't realize that FPA was pointed well short of the runway. If they had a synthetic depiction of the runway, they would have seen that the FPA and FPV were both aimed short. Simply lifting the FPV to the runway would have resulted in a shallow glidepath with their eyes aimed correctly but their landing gear still short. Adding two steps to the process guarantees not only a correct aim point but the correct glidepath as well.

Instead of pulling back on the pitch enough to place the FPV over the touchdown zone, the nose should be raised enough to move the FPV beyond the touchdown zone in an effort to intercept the correct glidepath. Once this is done, the FPA will start to move forward, essentially "walking" to the touchdown zone. Then you will be on the correct glidepath but aiming long. Simply lower the nose so the FPV coincides with the FPA right over the touchdown zone.

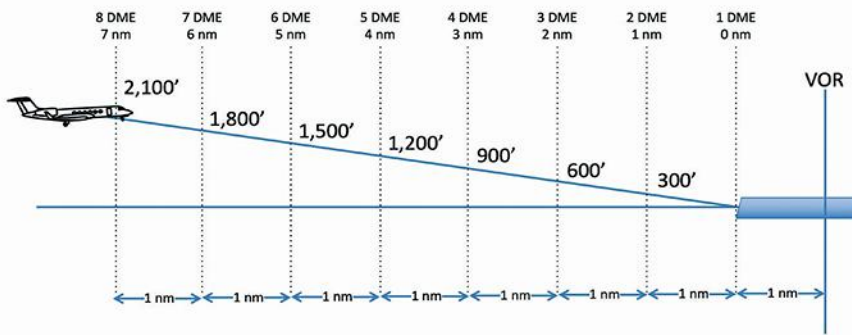

**Example: Judging altitude above the runway versus distance.**

## Curing the Problem With Repetition

I think understanding the geometry of your airplane when crossing the runway threshold is the first step to fixing a duck-under tendency. Knowing target altitudes with distance to go is a great way to ensure you aren't suckered in to a duck-under. Realizing that a dot or two low doesn't mean the same thing with various glidepath measuring systems should go far to prevent accepting a below-glidepath approach. But what about the problem of a visual illusion?

My most recent dive into the duck-under occurred as a civilian pilot while flying into Atlanta's DeKalb-Peachtree Airport (KPDK). At first glance, Runway 21L isn't short. In fact, at 6,001 ft. it borders on being comfortable for most business jets. But it has a 1,200-ft. displaced threshold and for some reason passing that much pavement was more than I could resist. So, I adopted a technique of aiming for the displaced threshold. After doing this for a year or so I asked the flight department about ways we were normalizing deviance. The No. 1 answer was Runway 21L at KPDK.

With some soul searching we realized that our performance numbers were based on landing in the touchdown zone. We agreed to straighten up and fly right. Our next approaches into Peachtree were right on glidepath and stopping wasn't a problem. We recently made an approach to minimums on Runway 21L; we crossed the displaced threshold at 50 ft., landed in the touchdown zone, and were at taxi speed well before the runway's end.

Thinking about that approach, I have to wonder about the view from the cockpit of RC-135S Exult 66. I wonder if the pilot had internalized the view of the approach lights from slightly below glidepath over the years and on the fateful day his eyes told him he was only slightly below his usual slightly below glidepath. I think he would have been well served by having the proper sight picture drilled into his head. The best way to do that is to fly the proper glidepath every time. **BCA**

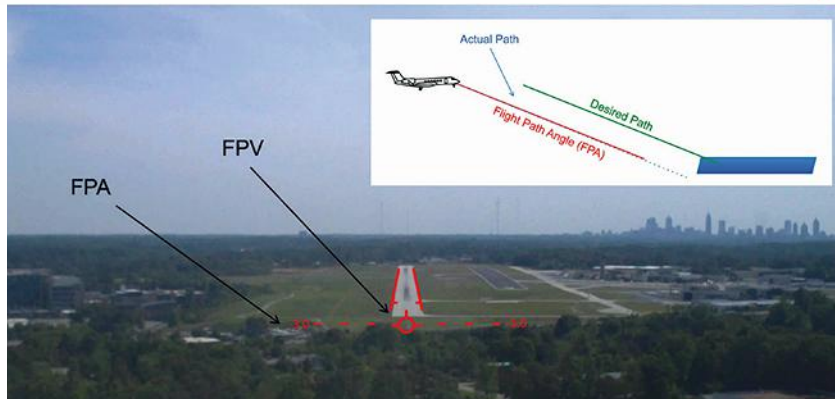

An approach into Atlanta DeKalb-Peachtree Airport (KPDK) with FPA and FPV aiming short of the runway.

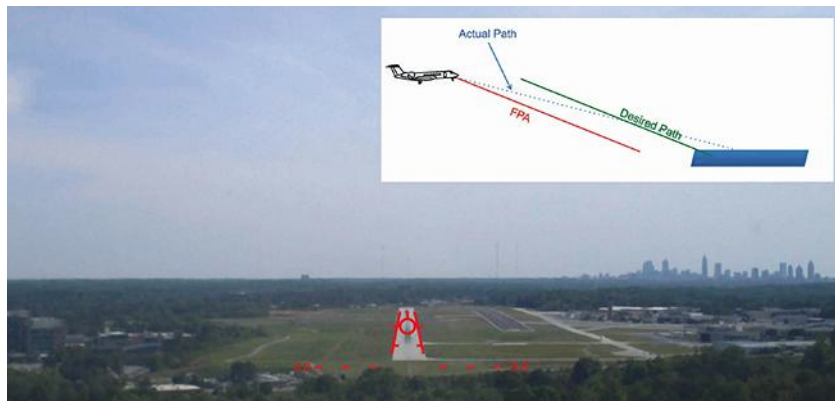

Raising the aircraft's FPV to "walk the path."

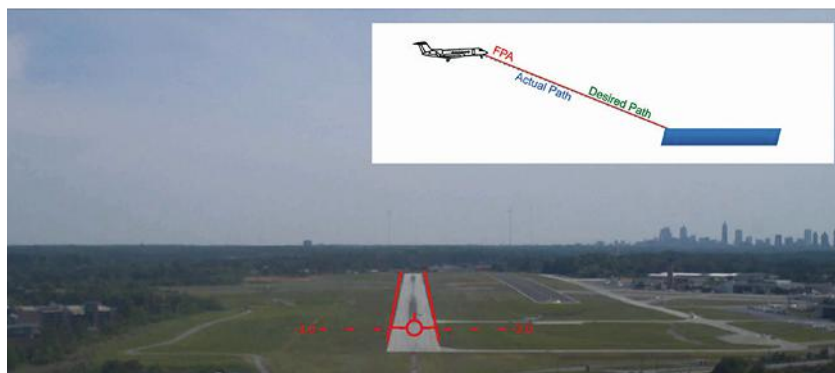

Returning the FPV to the FPA, right over the runway's touchdown zone.