



RECAT-EU

European Wake Turbulence Categorisation and Separation Minima on Approach and Departure

Edition: 1.1
Edition date: 15/07/2015
Status: Released Issue
Intended for: Stakeholders

RECAT-EU

DOCUMENT INFORMATION

TITLE					
"RECAT-EU" European Wake Turbulence Categorisation and Separation Minima on Approach and Departure					
Edition Number:	1.1	Edition Date:	15/07/2015		
Abstract					
This document presents the European Wake Turbulence Categorisation and Separation Minima on Approach and Departure "RECAT-EU", available for operational deployment. It also provides information about deployment benefits and possible support from EUROCONTROL to local Stakeholders.					
Keywords					
RECAT-EU	Wake turbulence	Runway throughput	Runway capacity		
Authors					
Frédéric Rooseleer, Vincent Treve					
Contact(s) Person	Email	Unit			
Paul Adamson	paul.adamson@eurocontrol.int	NMD/NOM/APT			
David Phythian	david.phythian@eurocontrol.int	NMD/NOM/APT			
Vincent Treve	vincent.treve@eurocontrol.int	ATM/RDS/APT			
Frédéric Rooseleer	frederic.rooseleer@eurocontrol.int	ATM/RDS/APT			
STATUS, AUDIENCE AND ACCESSIBILITY					
Status	Intended for		Accessible via		
Working Draft	<input type="checkbox"/>	General Public	<input type="checkbox"/>	Intranet	<input type="checkbox"/>
Draft	<input type="checkbox"/>	NMD Stakeholders	<input checked="" type="checkbox"/>	Extranet	<input type="checkbox"/>
Proposed Issue	<input type="checkbox"/>	Restricted Audience	<input type="checkbox"/>	Internet (www.eurocontrol.int)	<input checked="" type="checkbox"/>
Released Issue	<input checked="" type="checkbox"/>				

Publications

EUROCONTROL Headquarters

96 Rue de la Fusée

B-1130 BRUSSELS





Tel: +32 (0)2 729 1152

Fax: +32 (0)2 729 5149

E-mail: publications@eurocontrol.int

DOCUMENT APPROVAL

The following table identifies all management authorities who have successively approved the present issue of this document.

AUTHORITY	NAME AND SIGNATURE	DATE
Head of ATM Airport Unit	Robert Graham 	25.08.15
Head of Network Manager Airport Unit	Paul Adamson 	25/08/15
Director ATM	Philippe Merlo 	25/8/15
Director Network Manager	Joe Sultana 	25/8/15
Director General	Frank Brenner 	28/8/15



CONTENTS

DOCUMENT INFORMATION	3
DOCUMENT APPROVAL	4
CONTENTS	5
EXECUTIVE SUMMARY	7
Chapter 1 Introduction	9
Chapter 2 RECAT-EU Solution	10
2.1 Project background	10
2.2 Problems tackled by RECAT-EU.....	10
2.3 How RECAT-EU works	11
2.4 RECAT-EU Safety Case	21
2.5 Benefits of RECAT-EU	21
Chapter 3 RECAT-EU Deployment.....	23
Appendix A Rationale of RECAT-EU design methodology	25
1. Produce a data-driven proposal with traceability of sources	25
2. Develop a logical categorisation and separation minima	25
3. Use a severity metric correlated to encounter test data	26
4. Use an enhanced wake decay model	26
5. Deliver performance and capacity benefits to Stakeholders	26
6. Feasibility of Approach traffic separation delivery with 6-categories	27
7. Build a robust safety case	27
Appendix B RECAT-EU Safety Case Documentation.....	29
ABBREVIATIONS	30

EXECUTIVE SUMMARY

This document presents the European wake turbulence categories and separation minima on approach and departure, "RECAT-EU", available for operational deployment.

The demand is high for airport capacity and efficiency at some European airports, and in particular for increased runway throughput.

During recent years, knowledge about wake vortex behaviour in the operational environment has increased thanks to measured data and improved understanding of physical processes. It is mainly for this reason that it was possible to revise wake turbulence categorisation and corresponding separation minima.

The European Organisation for the Safety of Air Navigation (EUROCONTROL), in consultation with its Stakeholders, has developed a re-categorisation of ICAO wake turbulence longitudinal separation minima on approach and departure, called "RECAT-EU".

The RECAT-EU scheme is based on a set of principles, comparing the wake generation and wake resistance between aircraft types, and splitting ICAO HEAVY and MEDIUM categories into 'Upper' ('Larger') and 'Lower' ('Smaller'). This split has been based on aircraft type characteristics.

This allows reduction of separation minima for some traffic pairs of aircraft, enabling runway throughput increase, whilst maintaining acceptable levels of safety.

Safety benefits are also delivered for some smaller aircraft types, by increasing their separation minima and/or change of category grouping, hence reducing the risk of wake turbulence-induced accidents for the most vulnerable types.

RECAT-EU is supported by a comprehensive safety case, based on a quantified pair-wise wake turbulence risk assessment, and reviewed during Stakeholders consultation over 9-month period.

The European Aviation Safety Agency (EASA) has then conducted a technical review, and, with complementary analysis and assurance provided by AIRBUS about CAT-A aircraft / A380, confirmed in a letter to Member States that the safety case report provides the assurance that the RECAT-EU wake turbulence scheme can be used by States and Air Navigation Service Providers as a basis to update their current schemes.

RECAT-EU deployment will bring immediate capacity benefits, with additional movements in peak traffic periods, and / or reduce time to land or depart a traffic sequence. These benefits are expected to further increase over time as the overall fleet mix is forecasted to evolve towards larger aircraft – a mitigation for the lack of runway capacity foreseen in EUROCONTROL's 2013 'Challenges to Growth' study.

RECAT-EU will also provide a more rapid recovery from adverse conditions, helping to reduce the overall delay and will also enable improvements in ATFM slot compliance through the flexibility afforded by reduced departure separations.

The cost of RECAT-EU deployment is considered to be moderate, limited to local flight data processing system changes associated with the new wake vortex categories, and controller training. Some resources may also have to be dedicated to awareness of flight crews.

The RECAT-EU deployment will necessitate a collaborative approach involving all Stakeholders: Air Navigation Service Provider, Airport-based Airline(s), Airport Company and Authorities.

Chapter 1 Introduction

The demand is high for airport capacity and efficiency at some European airports, and in particular for increased runway throughput from an ANS/ATM perspective.

Runway capacity and efficiency use is often directly linked with the minimum separation between aircraft. These minima are constrained by ATS surveillance capabilities and wake turbulence.

During recent years, knowledge about wake vortex behaviour in the operational environment has increased thanks to recorded data and improved understanding of physical processes. It is mainly for this reason that it was possible to revise wake turbulence categorisation and corresponding separation minima to enable optimisation of airport capacity and efficiency whilst maintaining acceptable levels of safety.

The European Organisation for the Safety of Air Navigation (EUROCONTROL), in consultation with its Stakeholders, has developed a re-categorisation of ICAO wake turbulence scheme and associated longitudinal separation minima on approach and departure, called “RECAT-EU”, to the benefits of Airports and ATM Network Performance enhancement.

Chapter 2 RECAT-EU Solution

2.1 Project background

The AIRBUS A380 marked a milestone in the ATM world, since it meant a new approach for design of wake turbulence separations. The traditional ICAO provisions were subjected to revision, as the new A380 overtook the largest passenger aircraft generating greater vortices than those from the 'HEAVY' category.

A European-led A380 ICAO Steering Group was established – with representatives from EUROCONTROL, EASA, AIRBUS, FAA and ICAO – to evaluate A380 wake turbulence and to establish recommendations to ICAO for its spacing.

Subsequent to ICAO's State Letters about separation minima for aircraft following A380, work was then extended to determine if global wake separation revision was possible.

A first proposal (known as RECAT-1) was reviewed by Stakeholders. Further improvements were required by European Air Navigation Service Providers in order to enhance capacity benefits and close some technical questions raised during the consultation.

In parallel, and in close cooperation with EUROCONTROL and EASA, AIRBUS was still conducting additional flight test for revising the A380 separation.

At this stage, it was agreed with EASA and AIRBUS, that the A380 work would be incorporated into the wider wake turbulence re-categorisation for Europe ('RECAT-EU') using the AIRBUS flight test as key elements of validation of the proposed metric used for RECAT-EU.

2.2 Problems tackled by RECAT-EU

A safe separation minimum implies to consider wake vortex generated by an aircraft but also the wake encounter impact and resistance of the following aircraft on departure or final approach.

Existing ICAO wake vortex separation rules (based upon the HEAVY, MEDIUM and LIGHT categorisation) were implemented over 40 years ago and have in some respect become outdated, resulting in States introducing their own local amendments.

2.3 How RECAT-EU works

- **Concept:**

It is a new categorisation of aircraft for the traditional ICAO, whose aim is to safely increase arrival and/or departure capacity at airports by redefining wake turbulence categories and their associated separation minimum.

- **What is the concept based on?**

Today's ICAO separations are based on certificated Maximum Take Off Mass (MTOM) and it includes three categories (i.e HEAVY, MEDIUM or LIGHT) allocating all aircraft into one of them. Because the separations are defined based on the worst case in each category, this leads to over separation in many instances.

Leader / Follower	A380-800	HEAVY	MEDIUM	LIGHT
A380-800		6 NM	7 NM	8 NM
HEAVY MTOM ≥ 136 tons		4 NM	5 NM	6 NM
MEDIUM 7 tons ≤ MTOM < 136 tons				5 NM
LIGHT MTOM < 7 tons				

Table 1: ICAO wake turbulence categories and separation minima

Note 1: The Airbus A380-800 (A388), with a maximum take-off mass in the order of 560 000 kg, is the largest passenger aircraft ever entered into revenue service. The aircraft is in the HEAVY wake turbulence category, which has no defined upper limit. For the A380-800, an ICAO State guidance released in 2008 recommends an increase in relation to the wake turbulence separation minima published in the ICAO Doc 4444 PANS-ATM.

Note 2: When a wake turbulence restriction is not required, then separation reverts to radar separation minimum (MRS):

- as prescribed by ICAO as minimum radar separation (MRS) being 3NM (or 2.5NM under given conditions described in Doc 4444), or;
- as prescribed by the appropriate ATS authority.

This means that each category may cover a wide range of different sized aircraft, what leads to over-conservative separations in many cases, and so a loss of runway throughput.

RECAT-EU

HEAVY category:

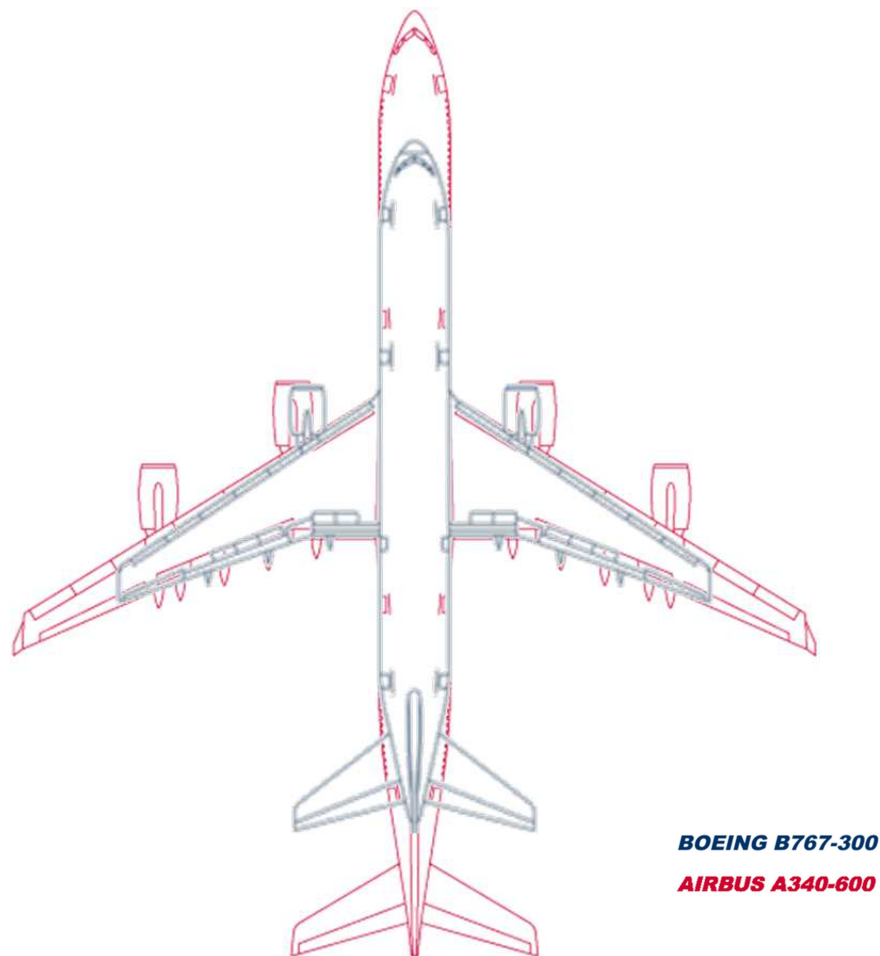

Figure 1: Comparison of aircraft size between AIRBUS A340-600 and BOEING B767-300 (planform top view) ¹

Both A346 and B763 are in the current ICAO HEAVY category, whilst their wing spans have a difference of more than 15 metres.

Therefore, they suffer from over-conservative separations when leader.

¹ “[A340FAMILY2v1.0](#)” by Julien.scavini, used under [CC BY](#) / derivative work from original

“[B767FAMILYv1.0](#)” by Julien.scavini, used under [CC BY](#) / derivative work from original

RECAT-EU

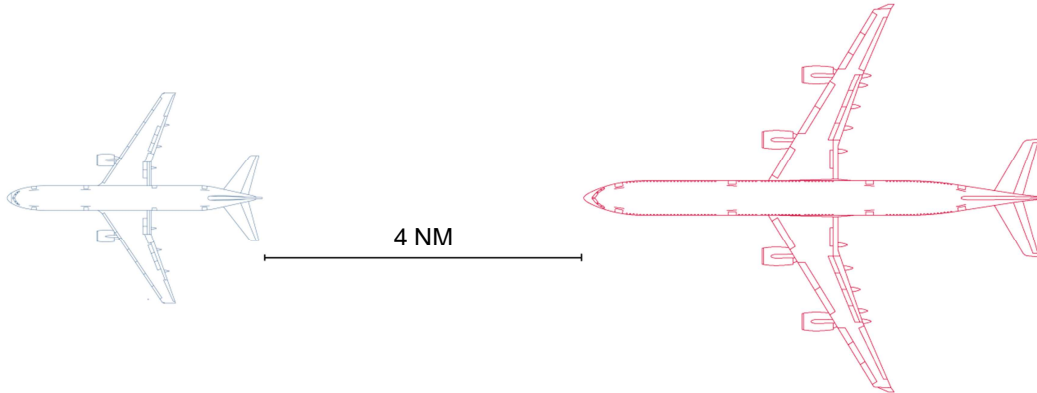

ICAO current separations
Safe, but over conservative.

BOEING B767-300
AIRBUS A340-600

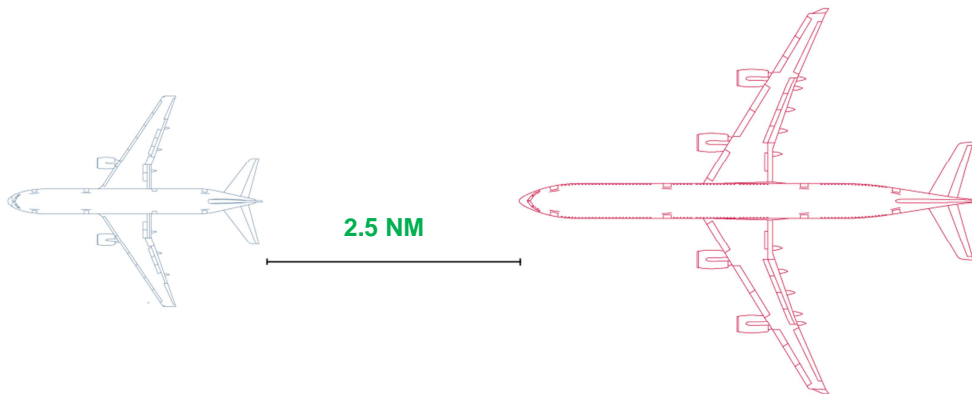

RECAT-EU separations
It is safe too, and the separation is more efficient.

Figure 2: Comparison of wake turbulence separation minimum applicable to A340-600 following B767-300 between ICAO and RECAT-EU scheme

RECAT-EU

MEDIUM category:

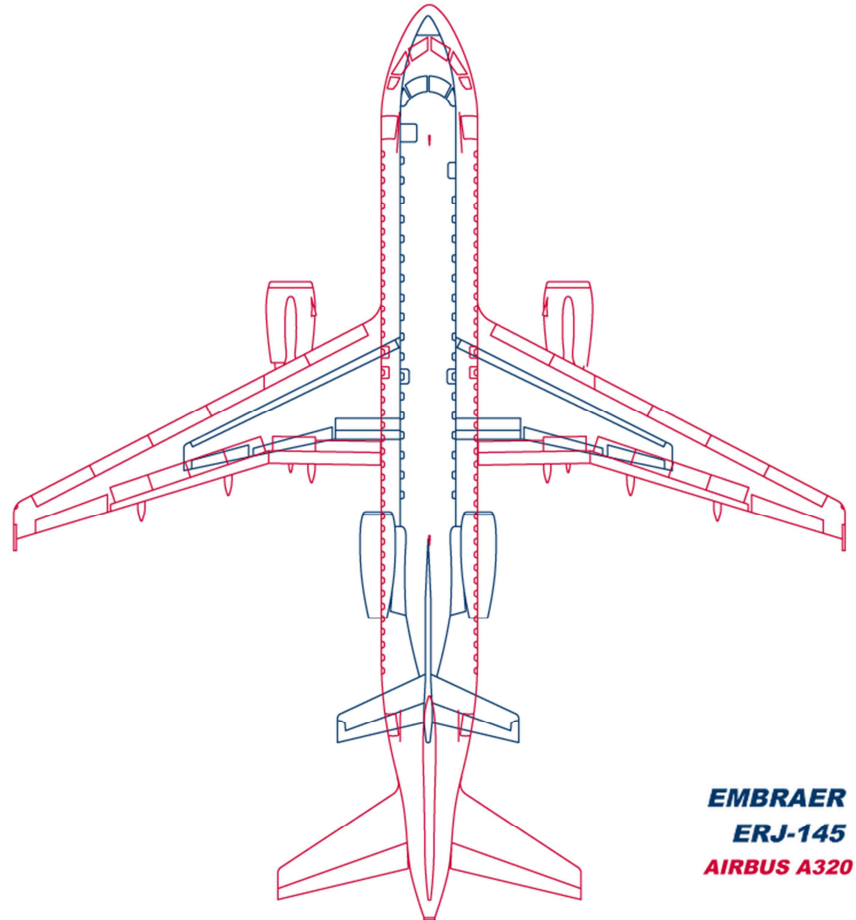

Figure 3: Comparison of aircraft size between AIRBUS A320 and EMBRAER ERJ-145 (planform top view)²

Both A320 and E145 are in the current ICAO MEDIUM category, whilst their wing spans have a difference of more than 12 metres.

Therefore, the A320 suffers from over conservative separations when follower.

² [“EMBRAER-ERJv1.0”](#) by Julien.scavini, used under [CC BY](#) / derivative work from original

[“A32XFAMILYv1.0”](#) by Julien.scavini, used under [CC BY](#) / derivative work from original

RECAT-EU

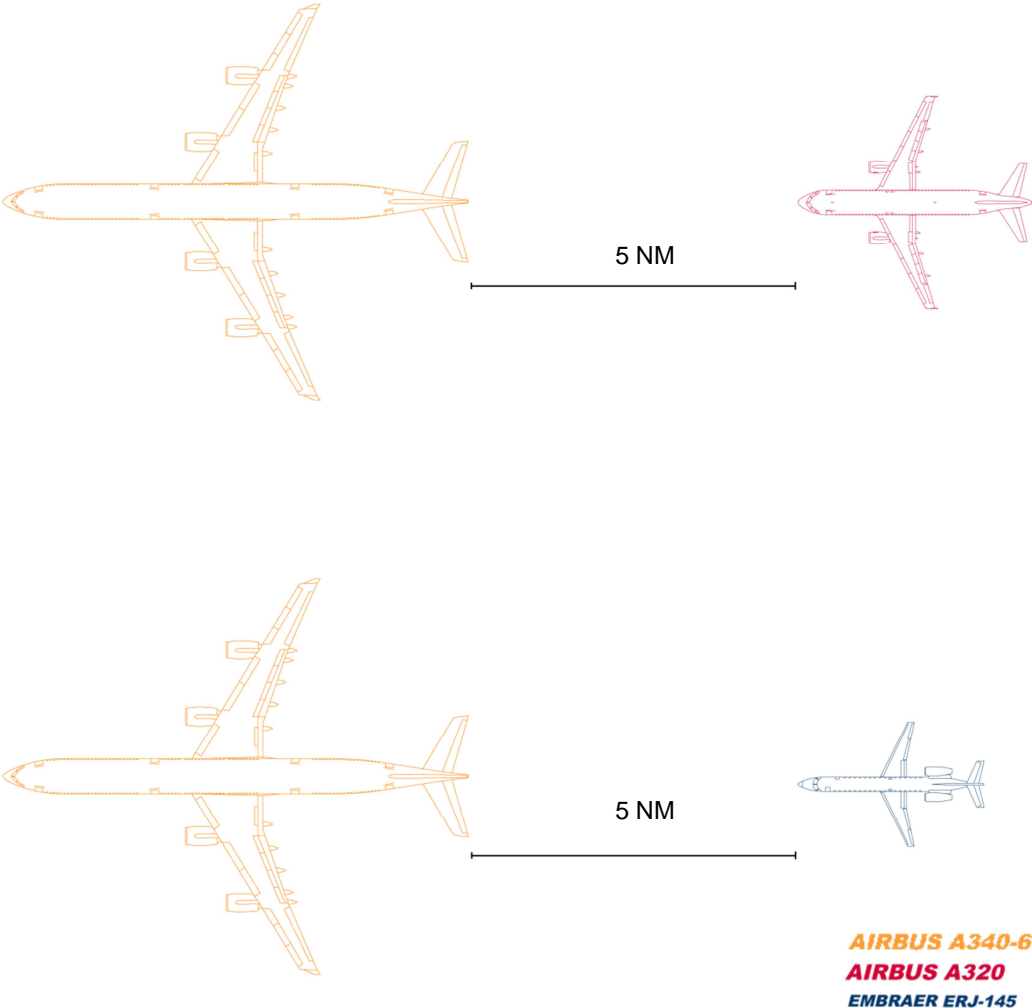

ICAO current separations

Safe, but over conservative for A320.

Figure 4: ICAO wake turbulence separation minimum applicable to A320 and to ERJ-145 following A340-600

RECAT-EU

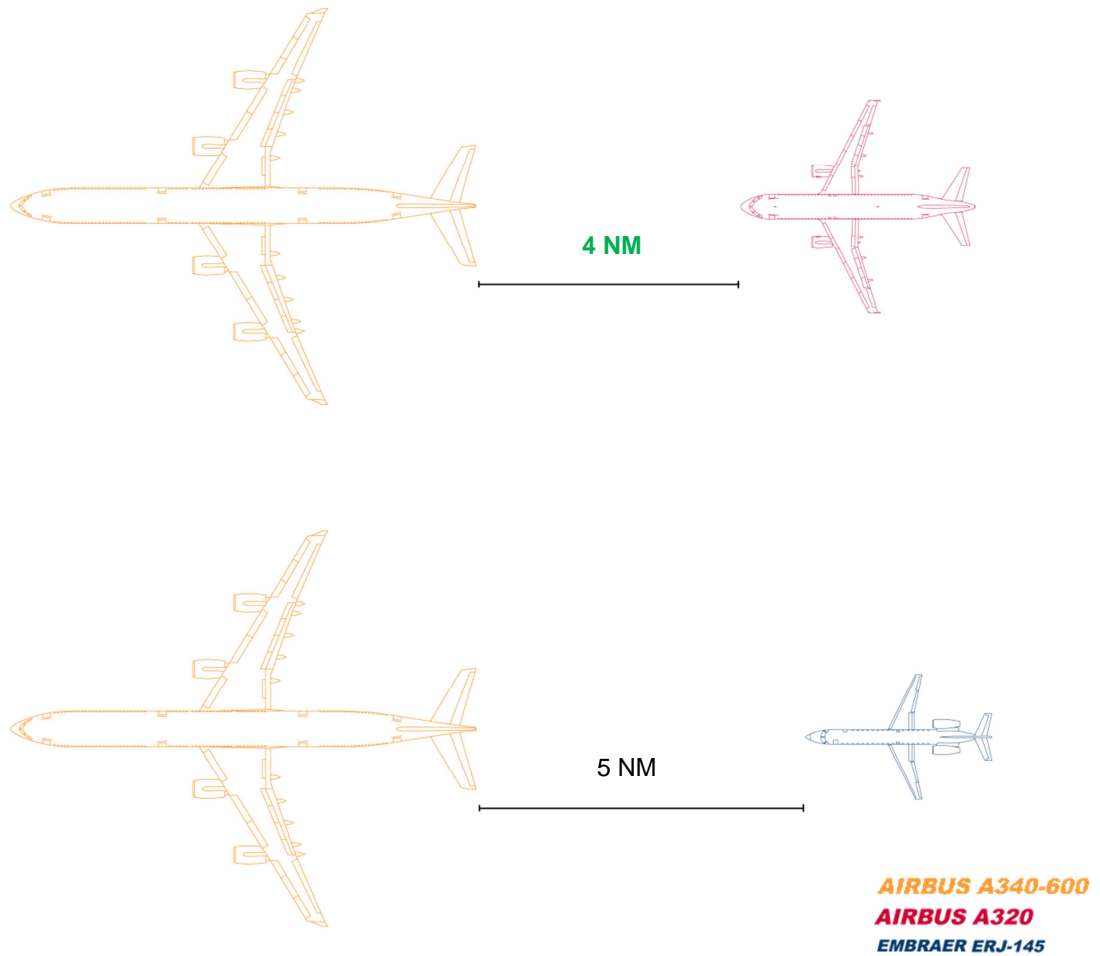

RECAT-EU separations

It is safe and the separation is more efficient.

Figure 5: RECAT-EU wake turbulence separation minimum applicable to A320 and to ERJ-145 following A340-600

Tackling this problem has brought out a much more precise categorisation in Europe: RECAT-EU. It divides the current HEAVY and MEDIUM categories into two sub-categories and creates a new SUPER HEAVY one for the AIRBUS A380.

RECAT-EU

The criteria used for categorisation of existing and new aircraft types are respectively provided in Figure 6.

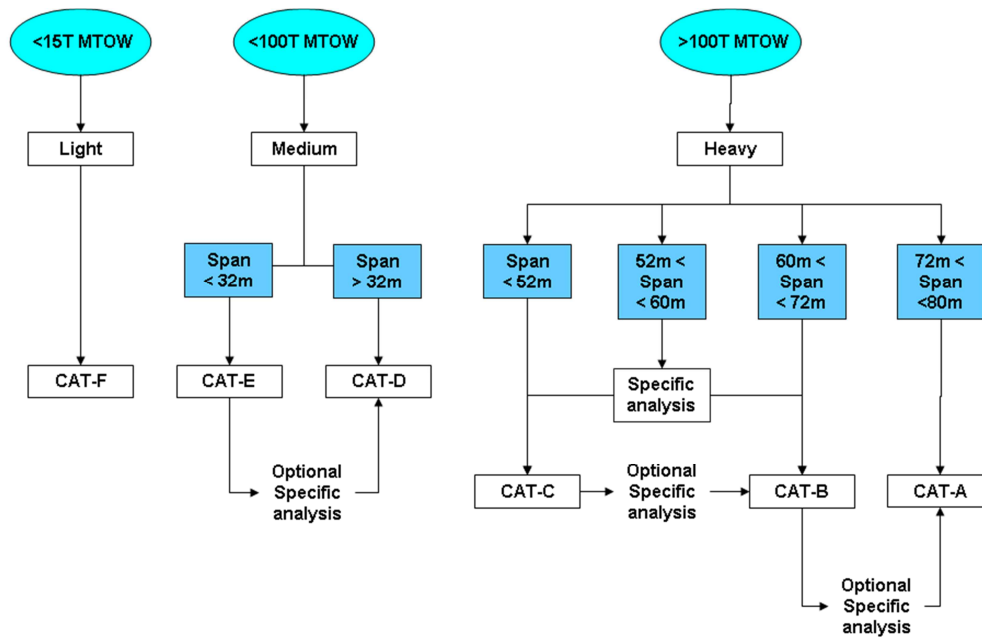













Figure 6: Categorisation process and criteria for assigning an existing aircraft type into RECAT-EU scheme

- **Aircraft new categories examples:**

CAT A	 A124	 A380
CAT B	 A332	 B744
CAT C	 MD11	 B763
CAT D	 B738	 A320
CAT E	 E190	 AT45
CAT F	 SF34	 LJ35

RECAT-EU

Figure 7: RECAT-EU wake turbulence categories and example aircraft type assignment

All certificated aircraft types (as per ICAO designators) before 1ST of January 2013 have been assigned in RECAT-EU scheme, with examples provided in Table 2.

'SUPER HEAVY'	'UPPER HEAVY'	'LOWER HEAVY'	'UPPER MEDIUM'	'LOWER MEDIUM'	'LIGHT'
'CAT-A'	'CAT-B'	'CAT-C'	'CAT-D'	'CAT-E'	'CAT-F'
A388	A332	A306	A318	AT43	FA10
A124	A333	A30B	A319	AT45	FA20
(...)	A343	A310	A320	AT72	D328
	A345	B703	A321	B712	E120
	A346	B752	AN12	B732	BE40
	A359	B753	B736	B733	BE45
	B744	B762	B737	B734	H25B
	B748	B763	B738	B735	JS32
	B772	B764	B739	CL60	JS41
	B773	B783	C130	CRJ1	LJ35
	B77L	C135	IL18	CRJ2	LJ60
	B77W	DC10	MD81	CRJ7	SF34
	B788	DC85	MD82	CRJ9	P180
	B789	IL76	MD83	DH8D	C650
	IL96	MD11	MD87	E135	C525
	(...)	TU22	MD88	E145	C180
		TU95	MD90	E170	C152
		(...)	T204	E175	(...)
			TU16	E190	
			(...)	E195	
				F70	
				F100	
				GLF4	
				RJ85	
				RJ1H	
				(...)	

Table 2: Example list of aircraft types assigned to RECAT-EU categories (Category names and letters are indicative)

The separations minima applicable between the RECAT-EU wake turbulence categories are provided in Table 3 and Table 4.

RECAT-EU

RECAT-EU scheme		“SUPER HEAVY”	“UPPER HEAVY”	“LOWER HEAVY”	“UPPER MEDIUM”	“LOWER MEDIUM”	“LIGHT”
Leader / Follower		“A”	“B”	“C”	“D”	“E”	“F”
“SUPER HEAVY”	“A”	3 NM	4 NM	5 NM	5 NM	6 NM	8 NM
“UPPER HEAVY”	“B”		3 NM	4 NM	4 NM	5 NM	7 NM
“LOWER HEAVY”	“C”		(*)	3 NM	3 NM	4 NM	6 NM
“UPPER MEDIUM”	“D”						5 NM
“LOWER MEDIUM”	“E”						4 NM
“LIGHT”	“F”						3 NM

Table 3: RECAT-EU WT distance-based separation minima on approach and departure

(*) means minimum radar separation (MRS), set at 2.5 NM, is applicable as per current ICAO doc 4444 provisions.

RECAT-EU scheme		“SUPER HEAVY”	“UPPER HEAVY”	“LOWER HEAVY”	“UPPER MEDIUM”	“LOWER MEDIUM”	“LIGHT”
Leader / Follower		“A”	“B”	“C”	“D”	“E”	“F”
“SUPER HEAVY”	“A”		100s	120s	140s	160s	180s
“UPPER HEAVY”	“B”				100s	120s	140s
“LOWER HEAVY”	“C”				80s	100s	120s
“UPPER MEDIUM”	“D”						120s
“LOWER MEDIUM”	“E”						100s
“LIGHT”	“F”						80s

Table 4: RECAT-EU WT time-based separation minima on departure

It remains optional to locally deploy part of the RECAT-EU scheme, or apply larger separation minima than proposed ones, or opt for a progressive application.

RECAT-EU

The Table 5 presents the delta variations in WT distance-based separation minima between categories when compared to reference ICAO reference scheme. The figures provided between brackets correspond to a MRS of 2.5 Nm as reference.

Follower Leader		"SUPER HEAVY"	"UPPER HEAVY"	"LOWER HEAVY"	"UPPER MEDIUM"	"LOWER MEDIUM"	"LIGHT"
		"A"	"B"	"C"	"D"	"E"	"F"
"SUPER HEAVY"	"A"	(+0.5 NM)	-2 NM	-1 NM	-2 NM	-1 NM	
"UPPER HEAVY"	"B"		-1 NM		-1 NM		+1 NM
"LOWER HEAVY"	"C"		-1 (-1.5) NM	-1 NM	-2 NM	-1 NM	
"UPPER MEDIUM"	"D"						
"LOWER MEDIUM"	"E"						-1 NM
"LIGHT"	"F"						(+ 0.5 NM)

Table 5: Difference in WT separation minima on approach between reference ICAO and RECAT-EU schemes (full proposal)

The Table 6 presents an overview of the delta variations in WT time-based separation minima between categories when compared to reference ICAO reference scheme.

Follower Leader		"SUPER HEAVY"	"UPPER HEAVY"	"LOWER HEAVY"	"UPPER MEDIUM"	"LOWER MEDIUM"	"LIGHT"
		"A"	"B"	"C"	"D"	"E"	"F"
"SUPER HEAVY"	"A"		-20s		-40s	-20s	
"UPPER HEAVY"	"B"				-20s		+20s
"LOWER HEAVY"	"C"				-40s	-20s	
"UPPER MEDIUM"	"D"						
"LOWER MEDIUM"	"E"						-20s
"LIGHT"	"F"						+20s

Table 6: Difference in WT separation minima on departure between reference ICAO and RECAT-EU schemes (full proposal)

RECAT-EU

2.4 RECAT-EU Safety Case

A safety case has been prepared by EUROCONTROL and reviewed during Stakeholders Consultation over 9 months. A detailed quantified wake turbulence risk assessment has been developed based on more than 100,000 wake measurements.

The rationale of RECAT-EU methodology is presented in Appendix A, and the main pieces of documentation is listed in Appendix B.

In October 2014, following a technical review, EASA confirmed in a letter that the *safety case report provides the assurance that the RECAT-EU wake turbulence separation scheme can be used by Member States as a basis to update current schemes.*

2.5 Benefits of RECAT-EU

ATS can expect immediate benefits from RECAT-EU deployment in terms of runway capacity (increased throughput) and operational efficiency:

- The runway throughput benefits can reach 5% or more during peak periods depending on individual airport traffic mix
- For an equivalent throughput, RECAT-EU also allows a reduction of the overall flight time for an arrival or departure sequence of traffic, and this is beneficial to the whole traffic sequence. This may offer more flexibility for the Controllers to manage the traffic.
- RECAT-EU will also enable more rapid recovery from adverse conditions, helping to reduce the overall delay and will also enable improvements in ATFM slot compliance through the flexibility afforded by reduced departure separations
- The gain in capacity could even increase further by 2020 due to evolution of traffic mix. Indeed, the benefits are expected to further increase over time as the overall fleet mix is forecasted to evolve towards larger aircraft, a mitigation for the lack of runway capacity foreseen in EUROCONTROL's 2013 'Challenges to Growth' study.

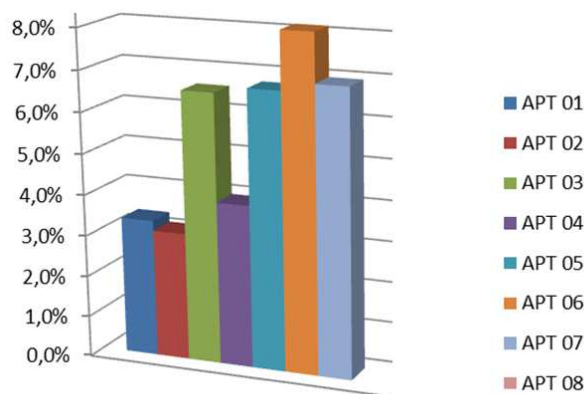

Figure 8: Arrival throughput increase enabled by RECAT-EU with predicted 2017 traffic mix during morning peak period

Chapter 3 RECAT-EU Deployment

The RECAT-EU scheme may be applied in full or in part, to update or replace the current wake separation scheme applied locally.

The operational use of RECAT-EU scheme will require limited changes to the ATM functional system. These changes must be subject to a local safety assessment.

Does it require deployment of new technologies (e.g., tools)?

No. RECAT-EU will mean a minimum system update, as it only requires updating local flight plan in the strip, adaptations to the Approach and Tower traffic surveillance display with new wake turbulence category designations, and publications of new applicable minima.

ATCO will need to be trained to work with the six categories, and this can be conducted by use of ATC simulations.

Flight Crew must be made aware and briefed on the local change.

Regarding phraseology for ATC call, no change is needed since ICAO “HEAVY” types remain “HEAVY” in RECAT-EU.

On this basis, the cost of RECAT-EU deployment is therefore considered to be moderate, limited to local flight data processing system changes associated with the new wake vortex categories and controller training. Some resources may also have to be dedicated to awareness of flight crews.

The RECAT-EU deployment will necessitate a collaborative approach involving all Stakeholders: Air Navigation Service Provider, Airport-based Airline(s), Airport Company and Authorities.

EUROCONTROL promotes and recommends the deployment of RECAT-EU as a solution to enhance the Airport throughput performance, which contributes to the ATM Network Performance.

EUROCONTROL will support deployment of RECAT-EU at Airports, with the following proposed contribution:

- ➔ Present RECAT-EU solution and safety case to local Stakeholders (Airlines, Pilots, ANSP, Airport, Authorities);
- ➔ Facilitate RECAT-EU ATC application (e.g. with material on RECAT-EU);
- ➔ Advise and provide guidance for local safety case development.

Appendix A Rationale of RECAT-EU design methodology

The RECAT-EU methodology is built on gained knowledge about wake physics during several EC. R&D projects (ATC WAKE, CREDOS,...) and expertise developed by EUROCONTROL with the ICAO working group activity and safety cases on A380 and B747-8 wake separation and during a first wake related concept in CDG in 2008 (WIDAO).

The rationale behind the RECAT-EU development was therefore:

1. Produce a data-driven proposal with traceability of sources

The RECAT-EU safety validation is based on a relative and quantitative wake turbulence risk assessment, based on extensively measured wake datasets¹, aircraft geometry and final approach speed profiles characterized per aircraft types².

Wake data collected at London Heathrow and Frankfurt were made available for allowing reviewer (EASA) to re-run the analysis and confirm the results of the EUROCONTROL Safety Case³.

The final approach speed profiles have been established from Mode-S and RADAR measurements collected during 2 years respectively at London Heathrow and Paris Charles de Gaulle.

Aircraft wing geometries were extracted from referenced airframe manufacturers' documentation.

2. Develop a logical categorisation and separation minima

The categorisation is based on logical aircraft type clustering⁴ (suggested and produced by French DGAC) and safety criteria, without optimisation for a specific traffic mix.

¹ RECAT-EU Safety Case - Appendix C - Wake Vortex Data (Document and Data Files, Covered by NDA)

² RECAT-EU Safety Case - Appendix D - Aircraft Types and Arrival Traffic Data (Document and Data Files, Covered by NDA)

³ RECAT-EU Safety Case report edition 1.3 issued by EUROCONTROL

⁴ RECAT-EU Safety Case - Appendix A - Initial Wake Turbulence Clustering And Categorisation (Document)

RECAT-EU

The RECAT-EU process is applied on a systematic basis to any aircraft type, and without adaptation from subject-matter expert (SME) judgement.

3. Use a severity metric correlated to encounter test data

The predictive wake turbulence severity metric has been validated with data from flight test campaign conducted by AIRBUS as recommended by EASA⁵ in the context of the A380 Flight Test working group.

The formulation of the severity metric was developed by a panel recognized European Experts, who were not contracted and contributed “under their own name”⁶.

4. Use an enhanced wake decay model

The wake decay characterisation on final approach is derived from the largest HEAVY aircraft wake database worldwide. Over 100.000 tracks were collected over 2 years at London Heathrow⁷ ('EGLL-1') allowing determination of wake decay profiles for HEAVY aircraft types as well as a coherent generic and normalized behaviour.

This confirmed the non-linear influence of individual vortex spacing on wake decay properties.

Generalisation of the results to departure phase was based on wake database collected in Frankfurt airport ('EDDF-2') described in CREDOS project documentation⁸.

5. Deliver performance and capacity benefits to Stakeholders

The runway throughput performance and capacity benefits from RECAT-EU are influenced by the prevailing and future traffic type mix and density. However, RECAT-EU can deliver a 5% or more capacity gain for the most constrained European airports, in some cases as much as 8%.

RECAT-EU also allows faster recovery to nominal planning and reduction of cumulative delay (See Annex 2).

The main reason of this difference comes from the categorisation and separation reduction for aircraft types which are predominant in European traffic (AIRBUS A320 and BOEING B737NG aircraft families). In addition, the reduced separation behind the A380 brings significant benefits for the airports where this aircraft is present in the traffic mix.

⁵ A380 Flight Test Working Group closure report for ICAO wake separation - EASA

⁶ RECAT-EU Safety Case - Appendix B - Wake Turbulence Severity Metric (Document and Data Files, Covered by NDA)

⁷ RECAT-EU Safety Case - Appendix C - Wake Vortex Data (Document and Data Files, Covered by NDA)

⁸ The CREDOS Project EDDF 6-Month Wake and Weather Dataset RWY25L/R

RECAT-EU

6. Feasibility of Approach traffic separation delivery with 6-categories

The operational feasibility of providing arrival or departure traffic separation using a 6-category scheme without an automated support tool relies on existing experience.

Indeed, approach and tower ATS in the UK has operated on a wake turbulence scheme with 6 categories for some years.

Moreover, during Approach and Tower ATC real-time simulation exercises recently conducted at the EUROCONTROL Experiment Centre (EEC), ATC Controllers have confirmed that they were able to adequately apply RECAT-EU scheme without an automated support tool, quickly adapting to the 6-category system.

7. Build a robust safety case

The comprehensive safety case is developed to provide safety assurance for RECAT-EU methodology and results, presenting structured arguments with supporting evidence and references, in line with European safety regulatory framework and best practices.

The RECAT-EU proposal and safety case was reviewed by a Task Force including EUROCONTROL Stakeholders (Civil Aviation Authorities and ANSPs), research community and aircraft manufacturers during a 9-months consultation.

EUROCONTROL modified and clarified the safety case to the satisfaction of all reviewers.

Based on the recommendation of the Task Force, the EUROCONTROL Agency Advisory Board agreed to submit the Safety case to EASA for review.

Appendix B RECAT-EU Safety Case Documentation

The RECAT-EU safety case documentation is essentially composed of the following:

1. EUROCONTROL RECAT-EU Safety case report, ed 1.3

Appendix A – Initial wake turbulence clustering and categorisation

Appendix B – Wake turbulence severity metric (Restricted access under NDA)

Appendix C – Wake vortex data (Restricted access under NDA)

Appendix D – Aircraft types and arrival traffic Data (Restricted access under NDA)

Appendix E1 – Wake turbulence risk assessment complementary information (Restricted access under NDA)

Appendix E2 – Wake turbulence risk assessment results for CAT-A / A380-800 (Restricted access under NDA)

Appendix E3 – Wake turbulence risk assessment results for CAT-A / A380-800 – Additional evidence (Restricted access under NDA)

Appendix E4 – Wake turbulence risk assessment for departure

Appendix F – RECAT-EU WT Categories for all aircraft types

2. EASA letter 2014(D) 54308 on RECAT-EU
3. EUROCONTROL & AIRBUS A350 Wake Turbulence Categorisation Safety Case report

Documents with restricted access covered by Non-Disclosure Agreement (NDA) contain proprietary data.

ABBREVIATIONS

ANSP	Air Navigation Service Provider
ATC	Air Traffic Control
ATS	Air Traffic Services
DGAC	Direction Générale de l'Aviation Civile
EC	European Commission
EASA	European Aviation Safety Agency
EUROCONTROL	European Organisation for the Safety of Air Navigation
FAA	United States of America Federal Aviation Administration
ICAO	International Civil Aviation Organisation
MRS	Minimum Radar Separation
MTOM	Maximum certificated Take-Off Mass
NATS	UK National Air Traffic Services
NDA	Non-Disclosure Agreement
NM	Nautical Mile
NMD	EUROCONTROL Network Manager Directorate
R&D	Research and Development
RECAT	Re-categorisation
WT	Wake Turbulence



© September 2015 – European Organisation for the Safety of Air Navigation (EUROCONTROL)

This document is published by EUROCONTROL for information purposes. It may be copied in whole or in part, provided that EUROCONTROL is mentioned as the source and it is not used for commercial purposes (i.e. for financial gain). The information in this document may not be modified without prior written permission from EUROCONTROL.

www.eurocontrol.int